



AI Workplace Occupancy Sensor

VS121-P

User Guide



Safety Precautions

Milesight will not shoulder responsibility for any loss or damage resulting from not following the instructions of this operating guide.

- ❖ The device must not be disassembled or remodeled in any way.
- ❖ To avoid risk of fire and electric shock, do keep the product away from rain and moisture before installation.
- ❖ Do not place the device where the temperature is below/above the operating range.
- ❖ Do not touch components which may be hot.
- ❖ The device must never be subjected to shocks or impacts.
- ❖ Make sure the device is firmly fixed when installing.
- ❖ Make sure the plug is firmly inserted into the power socket.
- ❖ Do not expose the device to where a laser beam equipment is used.
- ❖ Use a soft, dry cloth to clean the lens of the device. Stubborn stains can be removed using a cloth dampened with a small quantity of detergent solution, then wipe them dry.

Declaration of Conformity

VS121-P is in conformity with the essential requirements and other relevant provisions of the CE, FCC, and RoHS.



Copyright © 2011-2023 Milesight. All rights reserved.

All information in this guide is protected by copyright law. Whereby, no organization or individual shall copy or reproduce the whole or part of this user guide by any means without written authorization from Xiamen Milesight IoT Co., Ltd.

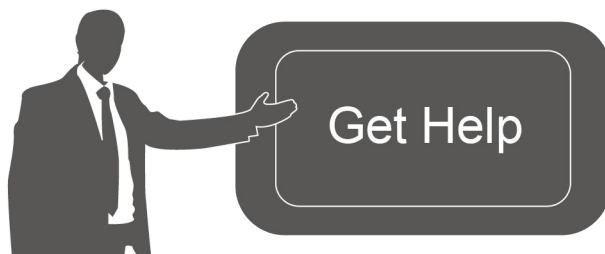

For assistance, please contact

Milesight technical support:

Email: iot.support@milesight.com

Support Portal: support.milesight-iot.com

Tel: 86-592-5085280

Fax: 86-592-5023065

Address: Building C09, Software Park
Phase III, Xiamen 361024,
China

Revision History

Date	Doc Version	Description
March 15, 2023	V 1.0	Initial version
April 20, 2023	V 1.1	Add installation height of high ceiling mount version

Contents

1. Product Introduction	5
1.1 Overview	5
1.2 Key Features	5
2. Hardware Introduction	5
2.1 Packing List	5
2.2 Hardware Overview	6
2.3 Reset Button and LED Indicator	6
2.4 Dimensions (mm)	6
3. Power Supply	7
4. Access the Sensor	7
5. Operation Guide	9
5.1 Live Video	9
5.2 Network	10
5.2.1 TCP/IP	10
5.2.2 RTSP	11
5.3 People Counting	12
5.3.1 Region People Counting	12
5.3.2 Line Crossing Counting	15
5.3.3 Recognition Scheme	17
5.3.4 Privacy Mask	18
5.4 System	19
5.4.1 User	19
5.4.2 System Info	20
5.4.3 Date & Time	20
5.4.4 Remote Management	21
5.4.5 System Maintenance	22
5.4.6 Security Service	23
5.4.7 About	23
6. Mount the Sensor	23
6.1 Recommended Height for Certain Object	23
6.2 Illuminance Requirements for AI Analysis	24
6.3 Recommended Installation for Line Crossing Counting	24
6.4 Factors Affecting Accuracy	26
6.5 Ceiling Installation	26
7. Report Content	26
7.1 Region People Counting	26
7.2 Line Crossing Counting	28

1. Product Introduction

1.1 Overview

Milesight VS121 is an AI workplace sensor designed to monitor occupancy and utilization in modern workspace, which can reach up to 98% recognition rate based on AI algorithm. Besides, the precise data collection and multiple privacy-friendly modes make it more user-friendly.

With PoE transmission, VS121 is available for more applications. And it equips rich serial interfaces such as DI, DO and RS485 for various scenarios. VS121 supports data push via HTTP for easily integration and allows for remote management via Milesight DeviceHub.

1.2 Key Features

- Recognition rate of up to 98% based on the advanced AI identification and analysis technology and wide detection range
- Support both people counting and occupancy detection
- Support up to 16 mapped regions for detection
- Allow for bi-direction line crossing people counting
- Support U-turn detection for effective data and precise detection
- Support both normal mode, blur mode, and privacy mask for up to 8 regions
- Support schedule detection
- Support Milesight DeviceHub management
- Adapt to more applications with rich industrial interfaces
- Support transmitting people counting and occupancy data via HTTP Post

2. Hardware Introduction

2.1 Packing List



1 × VS121 Device



4 × Wall Mounting
Kits

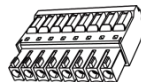

1 ×
Terminal Block

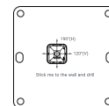

1 × Mounting
Sticker



1 × Quick Start Guide



1 ×
Warranty Card

! If any of the above items is missing or damaged, please contact your sales representative.

2.2 Hardware Overview

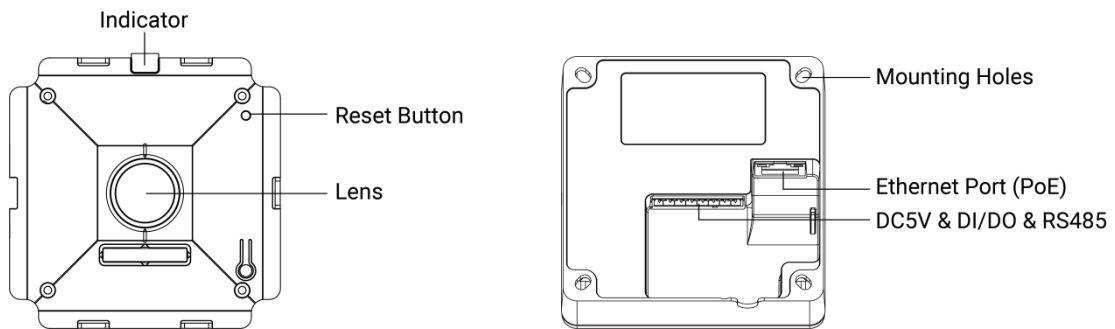

2.3 Reset Button and LED Indicator

Function	Action	LED Indication
On/Off Status	Power on or off the device.	On: Device is on
		Off: Device is off
Reset to Factory Default	Press and hold the reset button for more than 10 seconds.	Blink constantly.

2.4 Dimensions (mm)

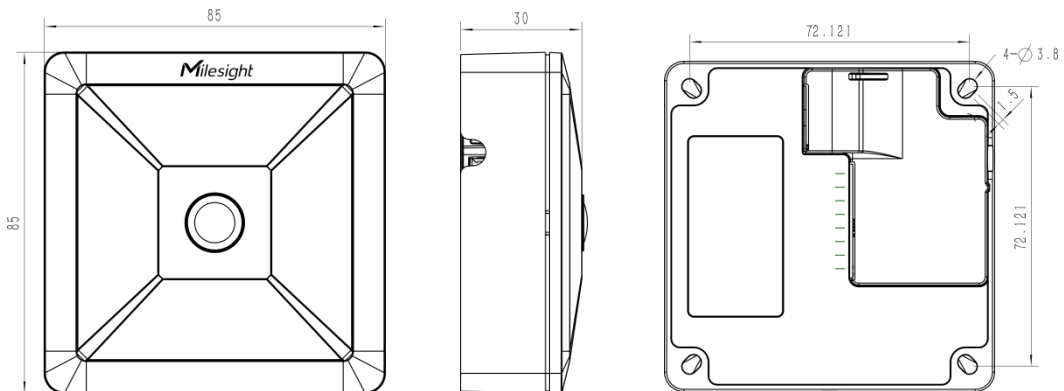

3. Power Supply

VS121-P can be powered by 802.3af standard PoE or DC 5V power adapter. Choose one of the following methods to power up the device.

- Powered by PoE Switch

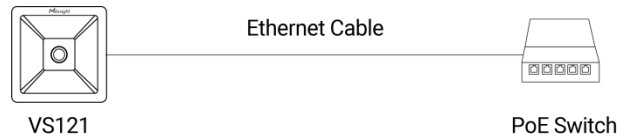

- Powered by PoE Injector

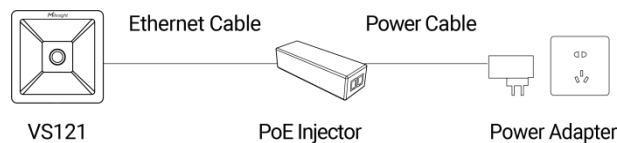

- Powered by DC Power Adapter

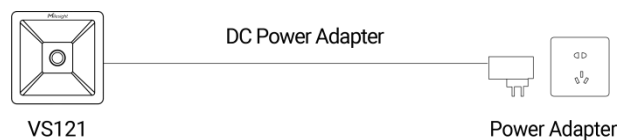

4. Access the Sensor

VS121-P provides user-friendly web GUI for configuration and users can get access to it via Ethernet port. The recommended browsers are Chrome, Microsoft Edge, and Safari. The default Ethernet IP of the sensor is **192.168.5.220** (can be found on the label).

Step 1: Power on the device and connect the Ethernet port to a PC.

Step 2: Change the IP address of computer to 192.168.5.0 segment as below:

- Go to **Start → Control Panel → Network and Internet → Network and Sharing Center → Ethernet → Properties → Internet Protocol Version 4 (TCP/IPv4)**.

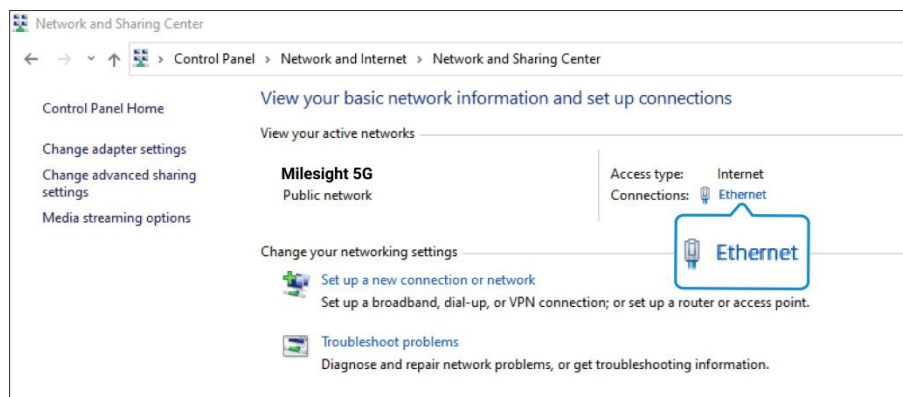

- Enter an IP address that in the same segment with sensor (e.g. 192.168.5.61, but please note that this IP address shall not conflict with the IP address on the existing network);

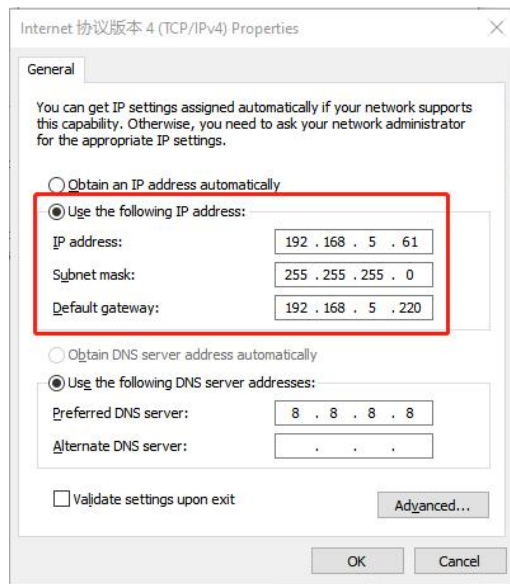

Step 3: Open the Browser and type 192.168.5.220 to get access to the GUI.

Step 4: Select the language.

Step 5: Users need to set the password and privacy mode when using the sensor for the first time. And, three security questions can also be set optionally. After configuration, use username (admin) and custom password to log in the sensor.

Note:

- 1) Password must be 8 to 32 characters long, containing at least one number and one letter.
- 2) You can click the "forgot password" in login page to reset the password by answering three security questions when you forget the password, if you set the security questions in advance.

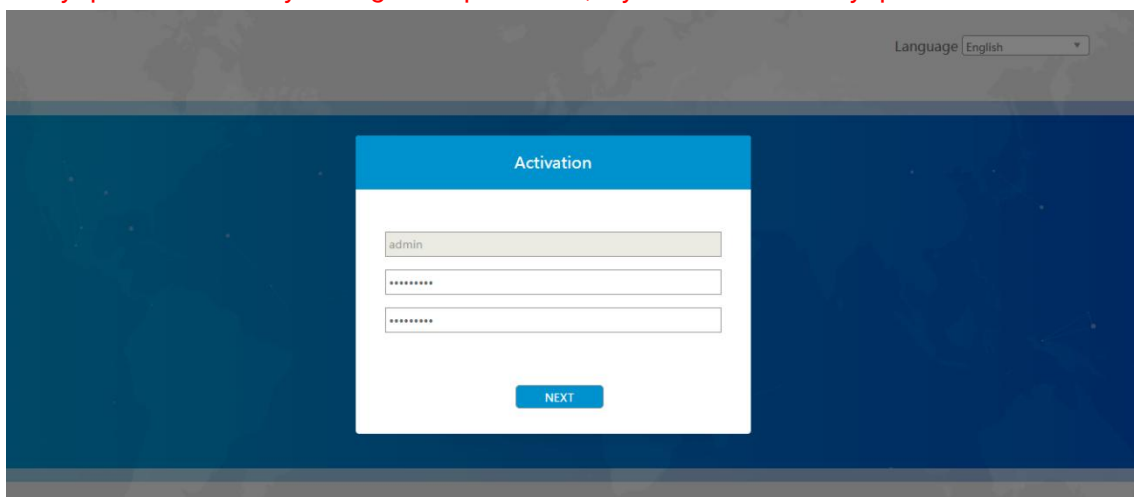

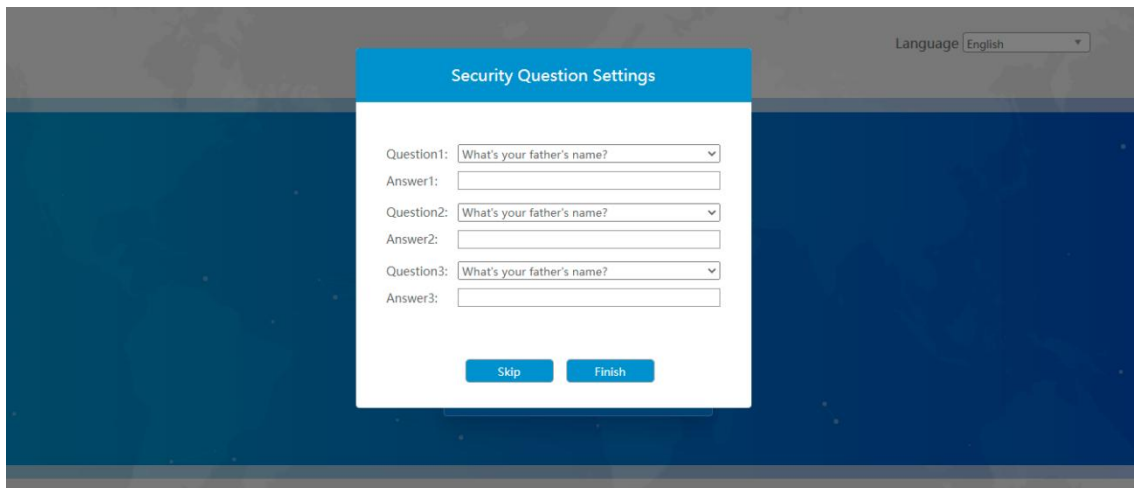
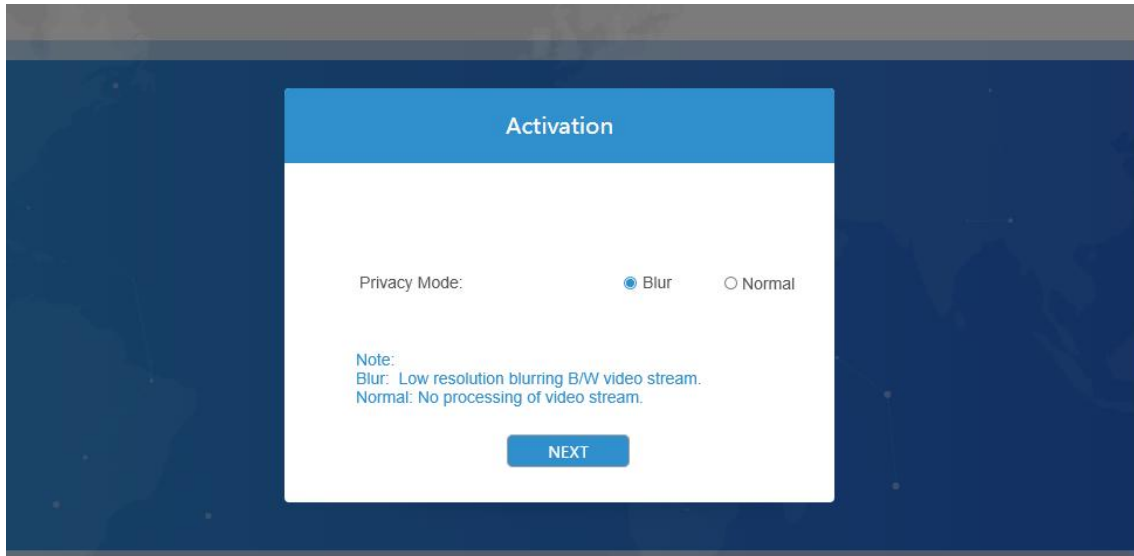



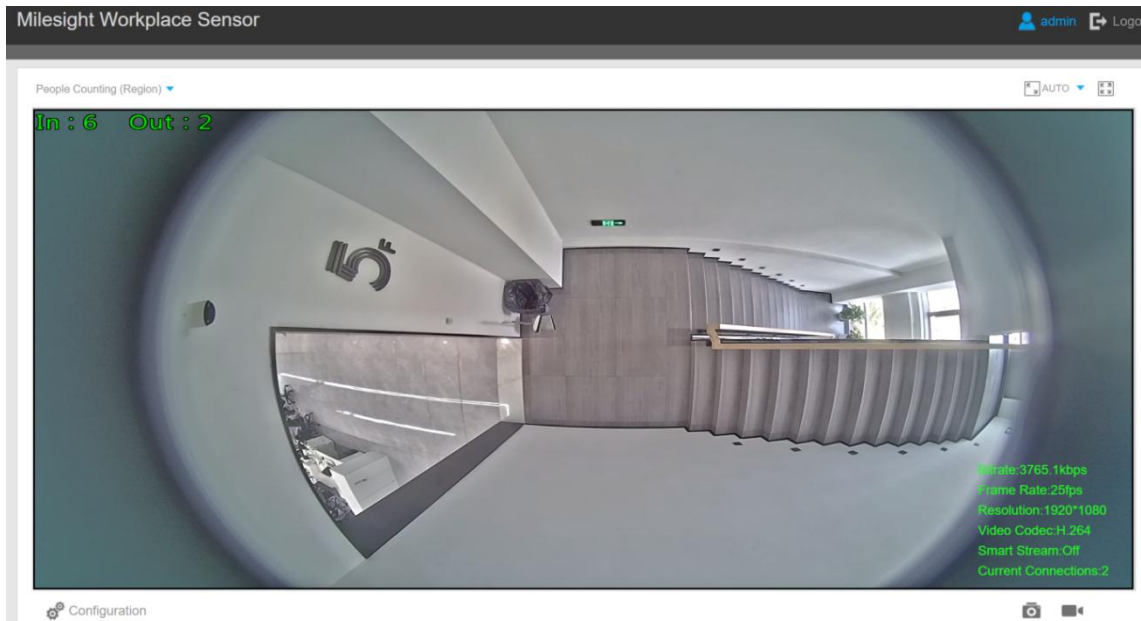

5. Operation Guide

5.1 Live Video

After logging on to the device web GUI successfully, user is allowed to view live video as follows.



Parameters	Description
 Configuration	Click to access the configuration page.
People Counting (Region) ▼	People Counting (Region): show the mapped or non-mapped regions of people counting. Line Crossing Counting: show the detection line and counting people it detected.
 Snapshot	Click to capture the current image. Note: this option is only available for normal privacy mode.
 Start/Stop Recording	Click to Start Recording video, click again to Stop Recording . Note: this option is only available for normal privacy mode.
 Windows Size & real size	Click to display images at a windows size.

5.2 Network

5.2.1 TCP/IP

Network

TCP/IP

RTSP

Get IPv4 address automatically
 Use fixed IPv4 address

IP Address:	192 . 168 . 68 . 71	Test
IPv4 Subnet Mask:	255 . 255 . 255 . 0	
IPv4 Default Gateway:	192 . 168 . 68 . 1	
Preferred DNS Server:	8 . 8 . 8 . 8	
IPv6 Mode:	Manual	▼
IPv6 Address:		
IPv6 Prefix:		
IPv6 Default Gateway:		
MTU:	1500	Bytes (1200~1500)

[Save](#)

Parameters	Description
IP Address	An address that used to identify the sensor on the network.
Test	Click test button to test if the IP address is conflicting.
IPv4 Subnet Mask	It is used to identify the subnet where the sensor is located.
IPv4 Default Gateway	The default router address.
Preferred DNS Server	The DNS Server translates the domain name to IP address.
IPv6 Mode	Select from "Manual", "Router Advertisement" or "DHCPv6".
IPv6 Address	IPv6 address used to identify the sensor on the network.
IPv6 Prefix	Define the prefix length of IPv6 address.
IPv6 Default Gateway	The default router IPv6 address.
MTU	Maximum transmission unit. The default value is 1500. Range: 1200~1500.

5.2.2 RTSP

RTSP is only available for Normal privacy mode.

Network

TCP/IP RTSP

RTSP Port:	<input type="text" value="52786"/>	
RTP Packet:	<input type="text" value="Better Compatibility"/>	▼
Multicast Group Address:	<input type="text" value="239 . 6 . 6 . 6"/>	
QoS DSCP(0~63):	<input type="text" value="0"/>	

[Save](#)

Parameters	Description
RTSP Port	The port of RTSP, the default is 554.
RTP Packet	Select from "Better Compatibility" and "Better Performance".
Multicast Group Address	Configure the address of multicast group.
QoS DSCP	The valid value range of the DSCP is 0-63.

RTSP URL

Stream	URL
Primary Stream	rtsp://IP:RTSP Port/main

Note:

- DSCP refers to the Differentiated Service Code Point, the value of DSCP is used in the IP header to indicate the priority of the data.
- A reboot is required for the settings to take effect.

5.3 People Counting

5.3.1 Region People Counting

Users can set the report settings and detection regions here.

Enable:	<input type="checkbox"/>
Number of People:	0

Settings

Report Regularly:	<input checked="" type="checkbox"/>
Reporting Interval (s):	<input type="text" value="300"/>
Report by Result:	<input checked="" type="checkbox"/>
Mode:	<input type="text" value="Once result changes"/>
HTTP Notification:	<input checked="" type="checkbox"/>
HTTP Notification URL:	<input type="text" value="URL 1"/>
Enable:	<input checked="" type="checkbox"/>
HTTP Method:	<input type="text" value="Post"/>
Snapshot:	<input checked="" type="checkbox"/>
URL:	<input type="text"/>
User Name:	<input type="text"/>
Password:	<input type="text"/>

Set Detection Region

Enable:	<input checked="" type="checkbox"/>
Detection Area:	<input type="text" value="Mapped Region"/>
Reporting Type:	<input type="text" value="Region People Counting"/>

Parameters	Description
Enable	Enable or disable region people counting feature.
Number of People	Show current number of people.
Report Regularly	Report the current number of people according to reporting interval. Reporting Interval: 5-3600 s, default: 300 s
Report by Result	Report according to the following changes of people number result: <ul style="list-style-type: none"> ● Zero to Non-zero/Non-zero to Zero ● Once result changes
HTTP Notification	Enable or disable to pop up the people counting data to specified HTTP URL.
HTTP Notification URL	Select among "URL 1", "URL 2" and "URL 3".
Enable	Enable or disable to configure URL and Username/Password.
HTTP Method	Fixed as Post.
Snapshot	Enable or disable snapshot feature.

	Note: the option is only available for normal privacy mode.
URL	The device will post the people counting data in json format to this URL.
User Name	The username used for authentication.
Password	The password used for authentication.
Enable	Enable the detection area customization feature. If disabled, the whole area will be the detection area.
Detection Area	<p>Select the customized area as either mapped or except mapped area. You can draw the area in the below screen. 16 regions can be set at most.</p> <p>Mapped Region: Only people who are in the mapped region will be detected.</p> <p>Non-mapped Region: Only people who are not in the mapped region will be detected.</p> <p>Note: when drawing the area, right click the mouse can make the area closed.</p>
Reporting Type	<p>When detection area is in Mapped Region type, users can select two reporting types:</p> <p>Occupancy: upload the occupancy status of per mapped region as 0 or 1.</p> <p>Region People Counting: upload the specific number of people of per mapped region. Note that the device allows to report the number in the 16 regions at most.</p>
Clear	Clear all areas you have drawn before.

Schedule Settings

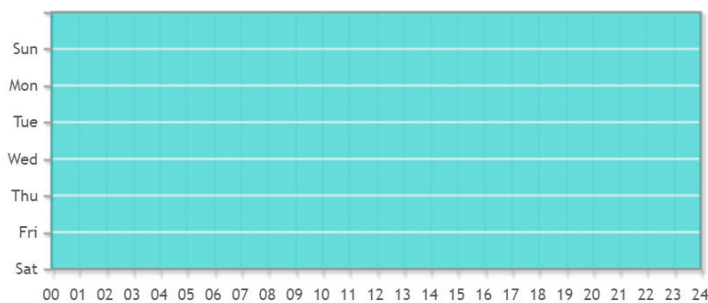

Edit

Milesight Workplace Sensor ✕

Time Schedule

	Period1	Period2	Period3	
<input checked="" type="checkbox"/>	<input type="text" value="00"/> : <input type="text" value="00"/> - <input type="text" value="24"/> : <input type="text" value="00"/>	<input type="text" value="00"/> : <input type="text" value="00"/> - <input type="text" value="00"/> : <input type="text" value="00"/>	<input type="text" value="00"/> : <input type="text" value="00"/> - <input type="text" value="00"/> : <input type="text" value="00"/>	Copy to Other Days
<input checked="" type="checkbox"/>	<input type="text" value="00"/> : <input type="text" value="00"/> - <input type="text" value="24"/> : <input type="text" value="00"/>	<input type="text" value="00"/> : <input type="text" value="00"/> - <input type="text" value="00"/> : <input type="text" value="00"/>	<input type="text" value="00"/> : <input type="text" value="00"/> - <input type="text" value="00"/> : <input type="text" value="00"/>	Copy to Other Days
<input checked="" type="checkbox"/>	<input type="text" value="00"/> : <input type="text" value="00"/> - <input type="text" value="24"/> : <input type="text" value="00"/>	<input type="text" value="00"/> : <input type="text" value="00"/> - <input type="text" value="00"/> : <input type="text" value="00"/>	<input type="text" value="00"/> : <input type="text" value="00"/> - <input type="text" value="00"/> : <input type="text" value="00"/>	Copy to Other Days
<input checked="" type="checkbox"/>	<input type="text" value="00"/> : <input type="text" value="00"/> - <input type="text" value="24"/> : <input type="text" value="00"/>	<input type="text" value="00"/> : <input type="text" value="00"/> - <input type="text" value="00"/> : <input type="text" value="00"/>	<input type="text" value="00"/> : <input type="text" value="00"/> - <input type="text" value="00"/> : <input type="text" value="00"/>	Copy to Other Days
<input checked="" type="checkbox"/>	<input type="text" value="00"/> : <input type="text" value="00"/> - <input type="text" value="24"/> : <input type="text" value="00"/>	<input type="text" value="00"/> : <input type="text" value="00"/> - <input type="text" value="00"/> : <input type="text" value="00"/>	<input type="text" value="00"/> : <input type="text" value="00"/> - <input type="text" value="00"/> : <input type="text" value="00"/>	Copy to Other Days
<input checked="" type="checkbox"/>	<input type="text" value="00"/> : <input type="text" value="00"/> - <input type="text" value="24"/> : <input type="text" value="00"/>	<input type="text" value="00"/> : <input type="text" value="00"/> - <input type="text" value="00"/> : <input type="text" value="00"/>	<input type="text" value="00"/> : <input type="text" value="00"/> - <input type="text" value="00"/> : <input type="text" value="00"/>	Copy to Other Days
<input checked="" type="checkbox"/>	<input type="text" value="00"/> : <input type="text" value="00"/> - <input type="text" value="24"/> : <input type="text" value="00"/>	<input type="text" value="00"/> : <input type="text" value="00"/> - <input type="text" value="00"/> : <input type="text" value="00"/>	<input type="text" value="00"/> : <input type="text" value="00"/> - <input type="text" value="00"/> : <input type="text" value="00"/>	Copy to Other Days

[Save](#)
[Reset](#)

Parameters	Description
Edit	Click Edit button to configure the time schedule.

Reset	Reset the time schedule to factory default.
-------	---

5.3.2 Line Crossing Counting

The sensor will count the number of people who cross a defined virtual line, then upload the counting data according to the reporting interval.

Enable:	<input checked="" type="checkbox"/>
Reporting Interval (s):	<input type="text" value="3600"/>
Filter U-turns:	<input checked="" type="checkbox"/>
HTTP Notification:	<input checked="" type="checkbox"/>
HTTP Notification URL:	<input type="text" value="URL 1"/>
Enable:	<input type="checkbox"/>
HTTP Method:	<input type="text" value="Post"/>
Snapshot:	<input type="checkbox"/>
URL:	<input type="text"/>
User Name:	<input type="text"/>
Password:	<input type="text"/>

Set Detection Line

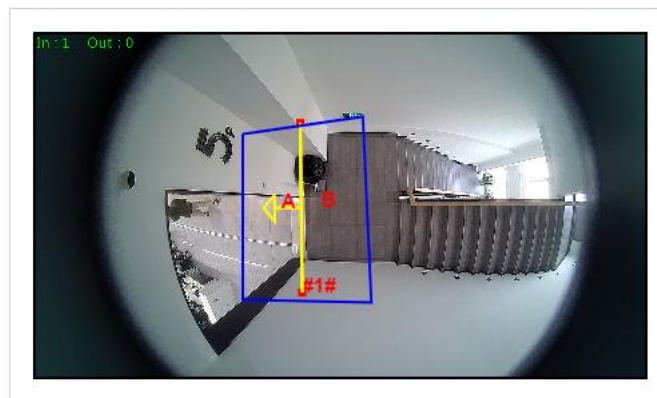

Draw Area Draw Line

Clear Area

Parameters	Description
Enable	Enable or disable line crossing counting feature.
Reporting Interval	Report the count value of people in/out during the reporting interval, the device will clean the previous values to re-count after reported, range: 5-3600 s, default: 300 s
Filter U-turns	When enabled, it allows to draw an area and the device will count the in and

	out values only when people cross along this area.
HTTP Notification	Enable or disable to pop up the alarm news to specific HTTP URLs.
HTTP Notification URL	Select among "URL 1", "URL 2" and "URL 3".
Enable	Enable or disable to configure URL, Username/Password.
HTTP Method	It's fixed as Post.
Snapshot	Enable or disable snapshot feature. Note: the option is only available for normal mode.
URL	The device will post the people counting data in json format to this URL.
User Name	The username used for authentication.
Password	The password used for authentication.
Set Detection Line	The device allows to set up only one line. For the detection line, crossing along the direction of the arrow is "In" and the opposite is "Out".
Clear Line	Clear the line you have drawn before.
Clear Area	Clear the are you have drawn before.

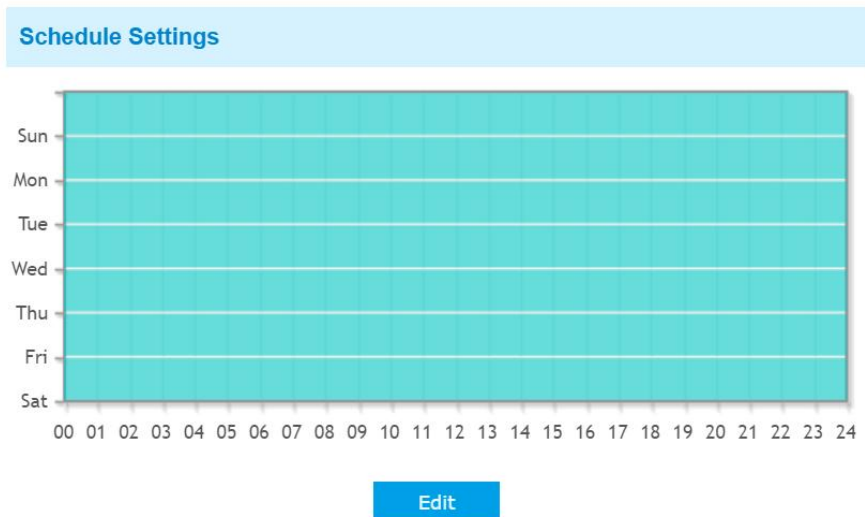

Milesight Workplace Sensor				
Time Schedule				
	Period1	Period2	Period3	
<input checked="" type="checkbox"/> Sunday	00 : 00 : 24 : 00	00 : 00 : 00 : 00	00 : 00 : 00 : 00	Copy to Other Days
<input checked="" type="checkbox"/> Monday	00 : 00 : 24 : 00	00 : 00 : 00 : 00	00 : 00 : 00 : 00	Copy to Other Days
<input checked="" type="checkbox"/> Tuesday	00 : 00 : 24 : 00	00 : 00 : 00 : 00	00 : 00 : 00 : 00	Copy to Other Days
<input checked="" type="checkbox"/> Wednesday	00 : 00 : 24 : 00	00 : 00 : 00 : 00	00 : 00 : 00 : 00	Copy to Other Days
<input checked="" type="checkbox"/> Thursday	00 : 00 : 24 : 00	00 : 00 : 00 : 00	00 : 00 : 00 : 00	Copy to Other Days
<input checked="" type="checkbox"/> Friday	00 : 00 : 24 : 00	00 : 00 : 00 : 00	00 : 00 : 00 : 00	Copy to Other Days
<input checked="" type="checkbox"/> Saturday	00 : 00 : 24 : 00	00 : 00 : 00 : 00	00 : 00 : 00 : 00	Copy to Other Days

Parameters	Description
Edit	Click Edit button to configure the time schedule.
Reset	Reset the time schedule to factory default.

Note:

1) The arrow direction of the detection line depends on your drawing direction.

Set Detection Line

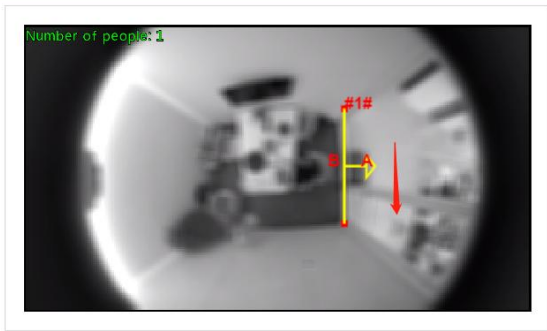

Set Detection Line

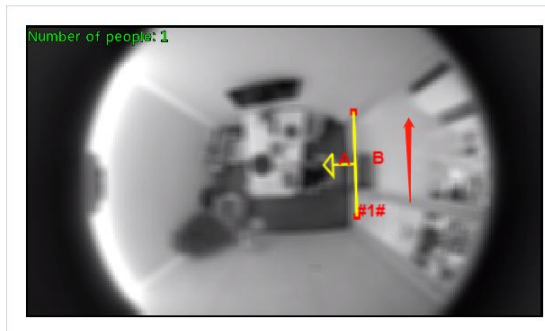

2) Ensure that the detected target can pass through the detection line completely. It's recommended that the detection line is perpendicular to the In/Out direction and on the center of detection area without other objects around.

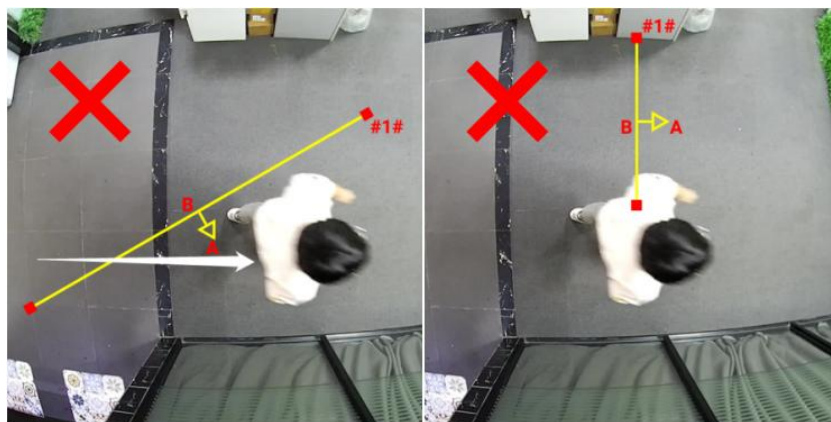

3) A redundant identification area needed to be left on both sides of the detection line for the target. This is to ensure that the sensor has stable recognition and tracking of this target before it passes the detection line, which will make the detection and count more accurate.

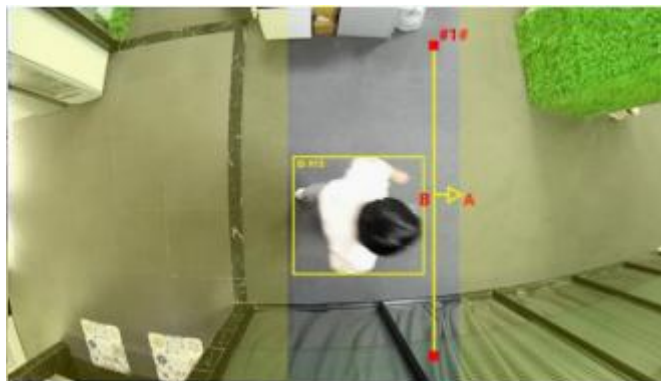

5.3.3 Recognition Scheme

You can select the recognition scheme for region people counting.

Algorithm

Recognition Scheme: Algorithm 1 ⓘ

Image

Power Line Frequency: 50Hz

Wide Dynamic Range: Off

Save

Parameters	Description
Recognition Scheme	<p>Select the recognition scheme based on your detection environment.</p> <p>Algorithm 1: Suitable for monitoring complex environments which have many objects, like office supplies (books, printers, lamps, etc.)</p> <p>Algorithm 2: Suitable for monitoring simple and clean environments like meeting rooms. It is suggested to use Algorithm 2 first.</p>
Image	<p>Power Line Frequency: Select based on your power source frequency standard, 60 Hz and 50 Hz are available.</p> <p>Wide Dynamic Range: This function which can capture and display both bright and dark areas in the same frame that enables details of objects in both bright and dark areas to be visible. It's recommended to enable this function when the scene has a clear contrast between light and dark (such as a corridor).</p>

5.3.4 Privacy Mask

Privacy mask enables to cover certain areas on the live video to prevent certain spots in the surveillance area from being viewed and prevent people within the area from being counted. You can set 8 mask areas at most.

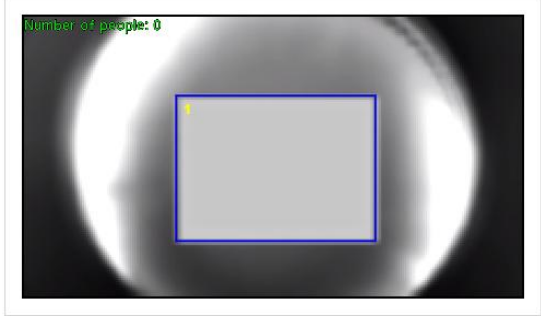

Clear All

Enable:

Type: White

ID	Name	Enable	Delete
1	Mask1	<input checked="" type="checkbox"/>	✘

Save

Note: Support up to 8 Privacy Mask areas.

Parameters	Description
Enable	Check the checkbox to enable the Privacy Mask function.
Clear All	Clear all areas you drew before.
Type	Select the color for the privacy areas, there are two colors available: White and Black

5.4 System

5.4.1 User

Security Question

Security Question: Edit

Account Management

Admin Password:

User Level: Administrator ▼

User Name:

New Password:

Confirm:

Save

Parameters	Description
Security Question	<p>Click Edit button to set three security questions for your device. In case that you forget the password, you can click Forget Password button on login page to reset the password by answering three security questions correctly.</p> <div style="border: 1px solid #ccc; padding: 10px; margin: 10px 0;"> <p style="text-align: center; color: #00bcd4; font-weight: bold; font-size: 0.9em;">Security Question Settings</p> <p>Admin Password: <input type="text"/></p> <p>Security Question1: What's your father's name? ▼</p> <p>Answer1: <input type="text"/></p> <p>Security Question2: What's your father's name? ▼</p> <p>Answer2: <input type="text"/></p> <p>Security Question3: What's your father's name? ▼</p> <p>Answer3: <input type="text"/></p> <p style="text-align: center; margin-top: 5px;">Save</p> </div> <p>There are twelve default questions below, you can also customize the security questions.</p>

	<p>What's your father's name? What's your favorite sport? What's your mother's name? What's your mobile number? What's your first pet's name? What's your favorite book? What's your favorite game? What's your favorite food? What's your lucky number? What's your favorite color? What's your best friend's name? Where did you go on your first trip? Customized Question</p>
Account Management	<p>Admin Password: enter the correct admin password before adding an account. User Level: It's fixed as Administrator. User Name: It's fixed as admin. New Password: Input password for the account. Confirm: Confirm the password.</p>

5.4.2 System Info

All information about the hardware and software can be checked on this page.

System	
Device Name:	<input type="text" value="Workplace Sensor"/>
Product Model:	VS121-P
SN:	6600D0233093
Hardware Version:	V1.0
Software Version:	31.7.0.80-iot2-b2
MAC Address:	24:E1:24:F5:4E:2F

Save

5.4.3 Date & Time

Here you can check and set the system time.

Current System Time	
Date:	08/03/2023
Time:	23:51:18
Set the System Time	
Time Zone:	(UTC-08:00) United States - Paci
Daylight Saving Time:	Automatic
<input checked="" type="radio"/> NTP server	
Server Address:	pool.ntp.org
NTP Sync:	<input checked="" type="checkbox"/> Interval: 1 day
<input type="radio"/> Manual	
Time:	08/03/2023 23:34:39
<input type="radio"/> Synchronize with computer time	
Date:	09/03/2023
Time:	15:51:19

Parameters	Description
Current System Time	Current date & time of the system.
Time Zone	Select a time zone according to your location.
Daylight Saving Time	Enable or disable the daylight saving time.
NTP Server Address	Setup the address of NTP server.
NTP Sync	Update the time according to the interval time regularly.
Time	Set the system time manually.
Synchronize with computer time	Synchronize the system time with the computer.

5.4.4 Remote Management

You can connect the device to the Milesight DeviceHub on this page so that you can manage the sensor centrally and remotely. For more details please refer to [DeviceHub User Guide](#).

DeviceHub	
Status:	Disconnected
Server Address:	<input type="text"/>
Activation Method:	Authentication Code
Authentication Code:	<input type="text"/>

Connect

Parameters	Description
Status	Show the connection status between the sensor and DeviceHub.
Server Address	IP address or domain of the DeviceHub.
Activation Method	Select activation method to connect the sensor to DeviceHub sever, the options are "Authentication Code" and "Account".
Authentication Code	Fill in the authentication code generated from the DeviceHub.
Account Name	Fill in the registered DeviceHub account (email) and password.
Password	
Connect/Disconnect	Click the button to connect/disconnect the sensor from the DeviceHub.

5.4.5 System Maintenance

System Upgrade

Software Version: 31.7.0.78-iot2

Local Upgrade: No file chosen

Reset after Upgrading

Note: Do not disconnect the power of the device during the upgrade.

Maintenance

Reset Keep the IP Configuration Keep the User Information

Export Config File:

Config File: No file chosen

Import Config File:

Reboot

Reboot the Device:

Parameters	Description
System Upgrade	<p>Software Version: The software version of the sensor.</p> <p>Local Upgrade: Click the Choose File button and select the upgrading file, then click the Upgrade button to upgrade. After the system reboots successfully, the update is done.</p>

	You can check Reset after Upgrading to reset the device after upgrading it. Note: Do not disconnect the power of the device during the upgrade process. The device will be restarted to complete the upgrading.
Maintenance	Reset settings: Click Reset button to reset the device to factory default settings Keep the IP Configuration: Check the option to keep the IP information when resetting Keep the User Information: Check this option to keep the user information when resetting Export Config File: Export configuration file. Import Config File: Click the Choose File button and select the configuration file, click Import button to import configuration file.
Reboot	Restart the device immediately

5.4.6 Security Service

SSH Settings

Enable SSH:	<input type="checkbox"/>
SSH Port:	<input style="width: 80%;" type="text" value="6022"/>

[Save](#)

Parameters	Description
Enable SSH	Enable SSH feature.
SSH Port	Set the port to access this sensor via SSH.

5.4.7 About

User can view some open source software licenses about the sensor by clicking the View Licenses button.

Open Source Software Licenses

[View Licenses](#)

6. Mount the Sensor

To better utilize the advantages of AI algorithm, there are some important steps to follow :

6.1 Recommended Height for Certain Object

Object	Height	Note
--------	--------	------

sitting object	>2.5m (8.2ft)	Commonly used for Region People Counting
standing object	>3m (9.8ft) (the optimum height is 3m)	Commonly used for Line Crossing Counting

Recommended detection ranges for region people counting at different heights:

Version	Height	Recommended detection range
Standard Version	2.5m	3m*4m
	3m	4.4m*5.7m
	3.5m	4.9m*6.4m
	4m	5.6m*7.4m
High Ceiling Mount Version	5m	3.5m*10m
	6m	4.5m*12m
	7m	5.5m*14m

6.2 Illuminance Requirements for AI Analysis

❖ Region People Counting

There is no requirement for illuminance, but we recommend enabling WDR function (Turn to [page 18](#)), which will make the image effect better.

❖ Line Crossing Counting

- We recommend that the illuminance is greater than 50Lux.
- When the illuminance is between 20~50Lux, we recommend disabling WDR function.
- When the illuminance is >50Lux and the scene has a clear contrast between light and dark (such as a corridor), we recommend enabling WDR function.

To know the illuminance of the current scene, you must use an illuminance meter, or you can refer to the following common environmental illuminance values:

place/environment	illuminance
Indoors at dusk	10Lux
cloudy indoor	5~50Lux
sunny indoor	100~1000Lux

6.3 Recommended Installation for Line Crossing Counting

- Make sure the sensor is facing straight down, in line with the ceiling.

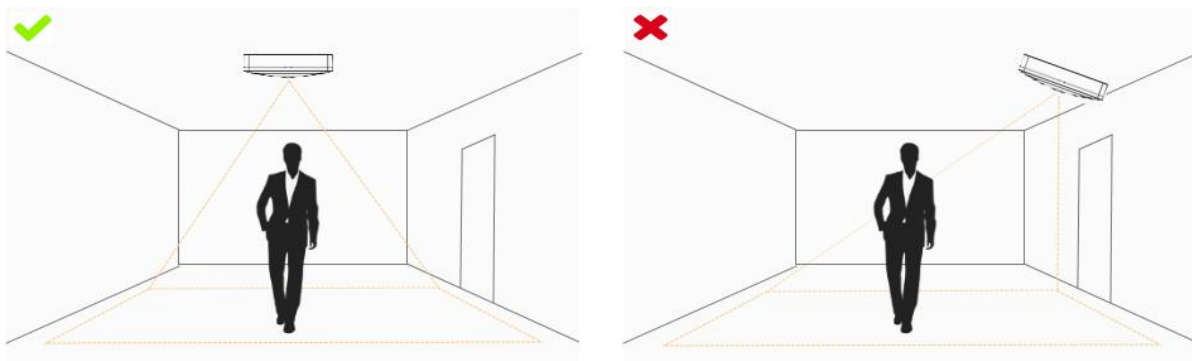

- Make sure there is sufficient white light on site.



- Avoid getting very strong light, like sunlight.

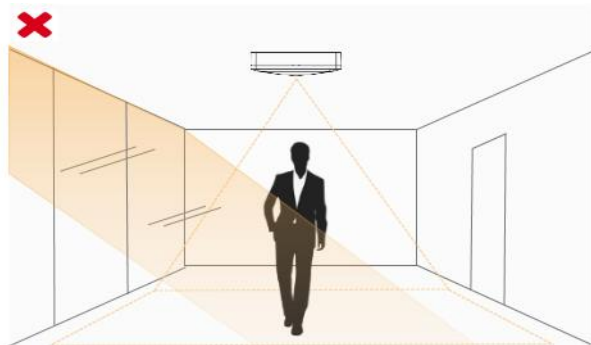

- Make sure there are no moving objects interfering in the counting area. For example, do not install the sensor too close to a door.

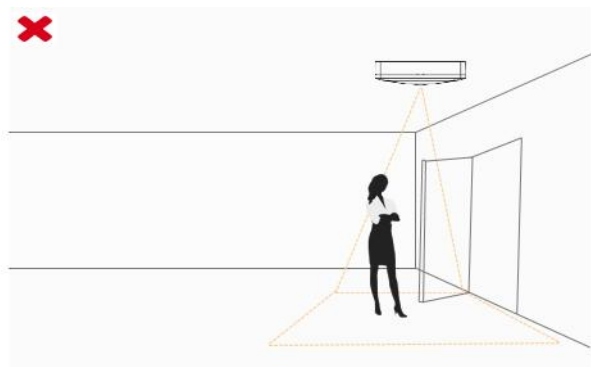
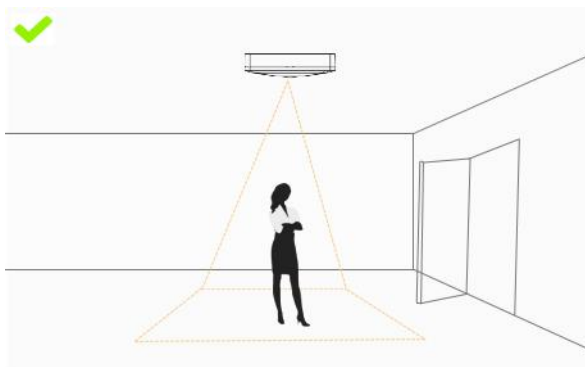

- Avoid installing the sensor near a mirror or avoid drawing the line to the mirror.

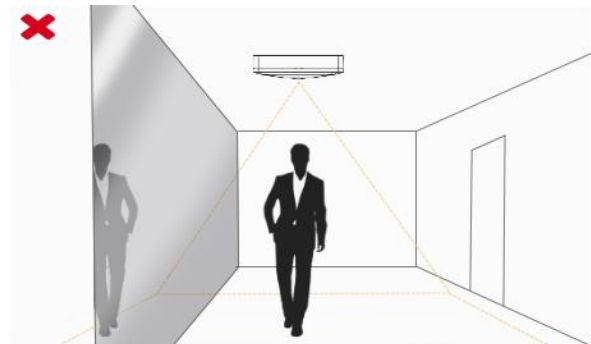
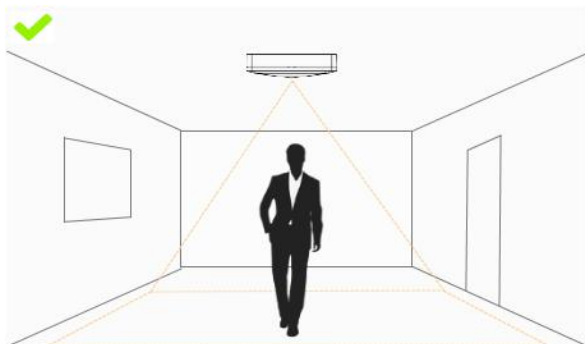

6.4 Factors Affecting Accuracy

- The color of hair or clothes is close to the floor color.

Reason: It will make it difficult for the algorithm to identify the correct object, thus affecting the accuracy.

- The floor color and wall color are black.

Reason: The brightness of the scene will be reduced due to the absorption of light by black.

- The contrast between light and dark in the scene is too strong.

Reason: It will cause the people to be backlight, which will affect the accuracy of the detection.

6.5 Ceiling Installation

Step 1: Ensure the thickness of ceiling is more than 30 mm, then attach the mounting sticker to the ceiling and drill 4 holes with a diameter of 6 mm.

Step 2: Fix the wall plugs into the ceiling holes.

Step 3: Remove the cover on the device, then fix the device to the wall plugs via mounting screws; remember to adjust the mounting direction according to the detection area requirement and direction sticker on the inner cover.

Step 4: Take the cover back to device; note that the Milesight Logo should be facing the LED indicator.

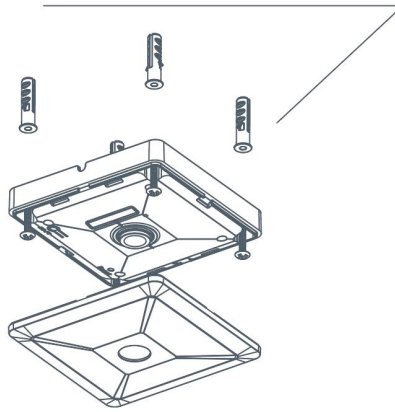

7. Report Content

VS121-P will post the people counting data in json format to HTTP URL.

7.1 Region People Counting

- **Periodic Report**

1. Occupancy Status

{

"event": "Region People Counting",

```

"device": "Workplace Sensor",
"time": "2022/12/20 18:15:52",
"report_type": "interval",
"current_total": 10,
"Max_counted": 12, //Maximum number of people during the reporting interval
"total_mapped_regions": 2,
"numbering_regions": [1, 2],
"occupancy": [1, 0],
"snapshot":
"/9j/4AAQSkZJRgABAQAAQABAAD/2wDFABALDA4MChAODQ4SERATGCgaGBY...(Image
code)"
}

```

2. Per Region People Counting

```

{
"event": "Region People Counting",
"device": "Workplace Sensor",
"time": "2022/12/20 18:15:52",
"report_type": "interval",
"current_total": 10,
"Max_counted": 12, //Maximum number of people during the reporting interval
"total_mapped_regions": 2,
"numbering_regions": [1, 2],
"current_counted": [5, 5],
"snapshot":
"/9j/4AAQSkZJRgABAQAAQABAAD/2wDFABALDA4MChAODQ4SERATGCgaGBY...(Image
code)"
}

```

● Trigger Report

1. Occupancy Status

```

{

```

```
"event": "Region People Counting",
"device": "Workplace Sensor",
"time": "2022/12/20 18:15:52",
"report_type": "trigger",
"current_total": 10,
"total_mapped_regions": 2,
"numbering_regions": [1, 2],
"occupancy": [1, 0],
"snapshot":
"/9j/4AAQSkZJRgABAQAAQABAAD/2wDFABALDA4MChAODQ4SERATGCgaGBY...(Image
code)"
}
```

2. Per Region People Counting

```
{
"event": "Region People Counting",
"device": "Workplace Sensor",
"time": "2022/12/20 18:15:52",
"report_type": "trigger",
"current_total": 10,
"total_mapped_regions": 2,
"numbering_regions": [1, 2],
"current_counted": [5, 5],
"snapshot":
"/9j/4AAQSkZJRgABAQAAQABAAD/2wDFABALDA4MChAODQ4SERATGCgaGBY...(Image
code)"
}
```

7.2 Line Crossing Counting

● Periodic Report

```
{
```

```
"event": "Line Crossing Counting",  
"device": "Workplace Sensor",  
"time": "2022/12/20 18:15:52",  
"report_type": "interval",  
"in_counted": 10,  
"out_counted": 10,  
"capacity_counted": 0, // = in_counted - out_counted  
"snapshot":  
"/9j/4AAQSkZJRgABAQAAQABAAD/2wDFABALDA4MChAODQ4SERATGCgaGBY...(Image  
code)"  
}
```

-END-